

Darstellung Maßübersicht

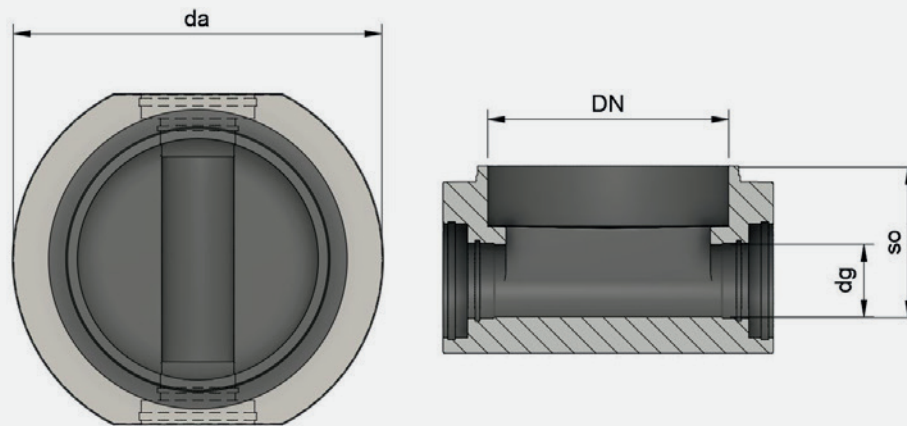

Maße Schächte

DN 1000		
dg	so	da
200	520	1560
250	570	1560
300	620	1560
400	720	1560
500	810	1560

DN 1200		
dg	so	da
300	620	1900
400	720	1900
500	810	1900
600	960	1900
700	1005	1900

DN 1500		
dg	so	da
500	810	2100
600	960	2100
700	1005	2100
800	1014	2100
1000	1340	2100

DN 2000		
dg	so	da
600	960	2600
700	1005	2600
800	1014	2600
1000	1340	2600
1200	1540	2600

Technische Änderungen vorbehalten

Stand: 04/2022